

# MA · MAD · MADD · MAT

## MA

**STANDARD TO-5  
HIGH-PERFORMANCE RELAY**

**QUALIFIED TO  
MIL-R-39016/9**

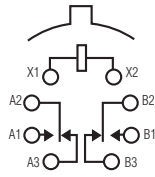

TERMINAL VIEW

**FEATURES**

- Hermetically sealed
- High shock & vibration ratings
- Spreader pads
- Excellent RF switching

## MAD

**STANDARD TO-5  
DIODE SUPPRESSED  
HIGH-PERFORMANCE RELAY**

**QUALIFIED TO  
MIL-R-39016/15**

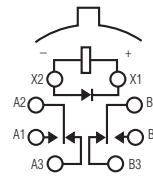

TERMINAL VIEW

**FEATURES**

- Suppression diode
- Hermetically sealed
- High shock & vibration ratings
- Spreader pads
- Excellent RF switching

## MADD

**STANDARD TO-5 DIODE  
SUPPRESSED/PROTECTED  
HIGH-PERFORMANCE RELAY**

**QUALIFIED TO  
MIL-R-39016/20**

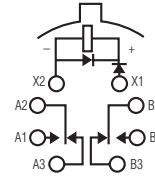

TERMINAL VIEW

**FEATURES**

- Suppression & protection diodes
- Hermetically sealed
- High shock & vibration ratings
- Spreader pads
- Excellent RF switching

## MAT

**STANDARD TO-5 DIODE  
SUPPRESSED/TRANSISTOR DRIVEN  
HIGH-PERFORMANCE RELAY**

**QUALIFIED TO  
MIL-R-28776/1**

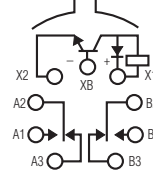

TERMINAL VIEW

**FEATURES**

- Transistor driver & suppression diode
- Hermetically sealed
- High shock & vibration ratings
- Spreader pads
- Excellent RF switching

**ELECTRICAL CHARACTERISTICS**

**CONTACT ARRANGEMENT**  
2 Form C (DPDT)

**CONTACT MATERIAL**  
Stationary:  
Gold/platinum/palladium/silver alloy (gold plated)  
Moveable:  
Gold/platinum/palladium/silver alloy (gold plated)

**CONTACT RESISTANCE**  
Before Life: 100 milliohms max. (measured @ 10 mA @ 6 Vdc)  
After Life: 200 milliohms max. (measured @ 1 A @ 28 Vdc)

**MECHANICAL LIFE EXPECTANCY**  
1 million operations

**COIL VOLTAGE**  
5 to 30 Vdc

**COIL POWER**  
675 mW max. @ 25°C

**DUTY CYCLE**  
Continuous

**PICK-UP VOLTAGE**  
Approximately 50% of nominal coil voltage

**PICK-UP SENSITIVITY**  
130 mW max. @ 25°C

**CONTACT RATINGS**

CONTACT LOAD	TYPE	OPERATIONS MIN.
1.0 A @ 28 Vdc	Resistive	100,000
250 mA @ 115 Vac, 60 Hz & 400 Hz	Resistive (case not grounded)	100,000
100 mA @ 115 Vac, 60 Hz & 400 Hz	Resistive	100,000
0.2 A @ 28 Vdc	Inductive (0.32 Henry)	100,000
0.1 A @ 28 Vdc	Lamp	100,000
30 μA @ 50 mVdc	Low Level	1,000,000
0.1 A @ 28 Vdc	Intermediate Current	50,000

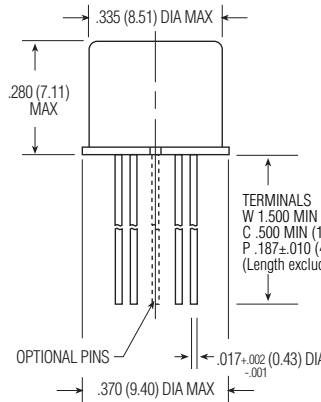

**ENCLOSURE**

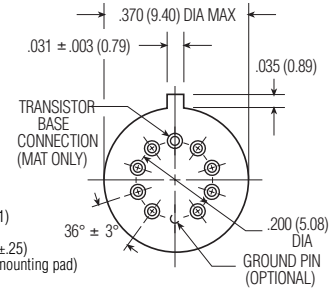

**HEADER**

TO-5 HIGH-PERFORMANCE RELAYS



**OPERATING CHARACTERISTICS**

**TIMING**

Operate Time:  
2.0 ms max.

Release Time:  
MA: 1.5 ms max.  
MAD/MADD: 4.0 ms max.  
(suppression diode,  
suppression/steering diodes)  
MAT: 7.5 ms max.  
(transistor driven)

**CONTACT BOUNCE**

1.5 ms max

**DIELECTRIC WITHSTANDING VOLTAGE**

Between Open Contacts:  
500 Vrms 60 Hz

Between Adjacent Contacts:  
500 Vrms 60 Hz

Between Contacts & Coil:  
500 Vrms 60 Hz

**INSULATION RESISTANCE**

10,000 megohms min. @ 500 Vdc  
1,000 megohms @ 500 Vdc  
(coil to case @ +125°C)

**ENVIRONMENTAL CHARACTERISTICS**

**TEMPERATURE RANGE**

-65°C to +125°C

**WEIGHT**

0.09 oz. (2.55 gms)  
0.10 oz. (2.80 gms) with spreader  
pad attached

**VIBRATION RESISTANCE**

30 G's, 10 to 3,000 Hz

**SHOCK RESISTANCE**

75 G's, 6 ±1 ms max.

**QPL APPROVAL**

MIL-R-39016/9 (JMA)  
MIL-R-39016/15 (JMAD)  
MIL-R-39016/20 (JMADD)  
MIL-R-28776/1 (JMAT)

**SEMICONDUCTOR CHARACTERISTICS**

**DIODE**

100 Vdc peak inverse voltage (PIV)  
1.0 Vdc max. transient voltage

**TRANSISTOR**

0.3 Vdc min. base turn off voltage  
6.0 Vdc min. emitter-base  
breakdown voltage (BV<sub>EBO</sub>) @ 25°C  
80.0 Vdc min. collector-base  
breakdown voltage (BV<sub>CBO</sub>) @ 25°C  
& I<sub>C</sub>=100 µA

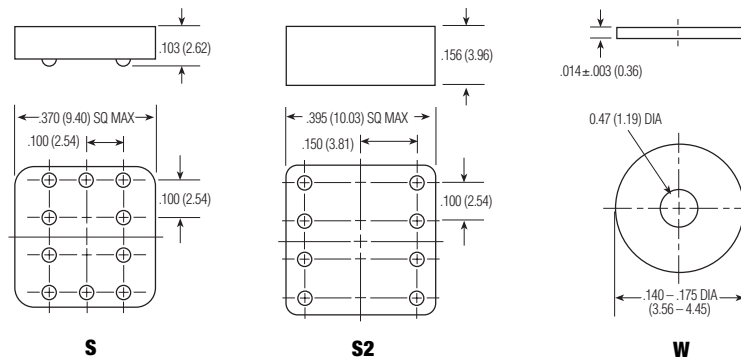

**SPREADER & MOUNTING PADS**

**COIL DATA**

NOM. COIL VOLTAGE (Vdc)	COIL RESISTANCE IN OHMS ±10% @ 25°C (Note 1)	COIL CIRCUIT CURRENT mA (MAX.) (Note 1&2)	COIL CIRCUIT CURRENT mA (MIN.) (Note 1&2)	PICKUP VOLTAGE Vdc (MAX.) @ 25°C (Note 2)	BASE TURN ON CURRENT mA (MAX.) @ 25°C	PICKUP VOLTAGE Vdc (MAX.) @ 125°C (Note 2)	BASE TURN ON CURRENT mA (MAX.) @ 125°C	DROP-OUT VOLTAGE Vdc (MIN.) (Note 2)	DROP-OUT VOLTAGE Vdc (MIN.) @ -65°C (Note 2)	NOM. COIL POWER (mW) @ 25°C	MAX. COIL VOLTAGE	COIL DESIG.
<b>MA/MAD</b>												
5.0	50	n/a	n/a	2.7	n/a	3.5	n/a	0.22	0.14	500	5.8	5
6.0	98	n/a	n/a	3.5	n/a	4.5	n/a	0.28	0.18	367	8.0	6
9.0	220	n/a	n/a	5.3	n/a	6.8	n/a	0.54	0.35	368	12.0	9
12.0	390	n/a	n/a	7.0	n/a	9.0	n/a	0.63	0.41	369	16.0	12
18.0	880	n/a	n/a	10.5	n/a	13.5	n/a	0.91	0.59	368	24.0	18
26.5	1,560	n/a	n/a	14.2	n/a	18.0	n/a	1.37	0.89	450	32.0	26
30.0	2,500	n/a	n/a	17.7	n/a	22.0	n/a	1.50	1.00	360	36.0	30
<b>MADD</b>												
5.0	39	128.2	93.2	3.2	n/a	4.0	n/a	0.6	0.6	641	5.8	5
6.0	78	78.3	58.3	4.0	n/a	5.0	n/a	0.7	0.7	462	8.0	6
9.0	220	42.9	33.0	6.3	n/a	7.8	n/a	0.9	0.8	368	12.0	9
12.0	390	32.8	25.6	8.0	n/a	10.0	n/a	1.1	0.9	369	16.0	12
18.0	880	22.1	17.5	11.5	n/a	14.5	n/a	1.4	1.1	368	24.0	18
26.5	1,560	18.5	14.8	15.2	n/a	19.0	n/a	1.8	1.4	450	32.0	26
<b>MAT</b>												
5.0	50	112.1	82.2	2.7	0.75	3.5	3.00	0.22	0.14	500	5.8	5
6.0	98	69.9	52.9	3.5	0.55	4.5	2.04	0.28	0.18	367	8.0	6
9.0	220	47.4	35.3	5.3	0.36	6.8	1.36	0.54	0.35	368	12.0	9
12.0	390	35.8	26.6	7.0	0.27	9.0	1.03	0.63	0.41	369	16.0	12
18.0	880	24.0	17.9	10.5	0.16	13.5	0.68	0.91	0.59	368	24.0	18
26.5	1,560	19.8	14.7	14.2	0.13	18.0	0.50	1.37	0.89	450	32.0	26

Note 1: Coil resistance not directly measurable. Coil current should be within limits shown when tested at nominal voltage at 25°C for 5 seconds max.  
Note 2: Set base current at 3 mA to 15 mA during measurements.

<b>SPECIFYING A PART NUMBER EXAMPLE:</b>	<b>TYPE</b>	<b>TERMINALS</b>	<b>DIODES</b>	<b>GROUND PINS</b>	<b>COILS</b>	<b>SPREADER/MOUNTING PADS</b>
	MA	C	D	G	-26	S

